



01 218 g/m



02 208 g/m



03 88 g/m



04 150 g/m



05 131 g/m



06 63 g/m



07 256 g/m



08 163 g/m



09 143 g/m



10 163 g/m



11 156 g/m



12 143 g/m



13 212 g/m



14 150 g/m



15 106 g/m



16 168 g/m



17 200 g/m



18 150 g/m



19 106 g/m



20 193 g/m



21 175 g/m



22 143 g/m



23 168 g/m



24 150 g/m

Trafilati in Gomma

Qualità EPDM* nera



25 75 g/m



28 93 g/m



31 270 g/m



34 212 g/m



37 63 g/m



40 188 g/m



43 143 g/m

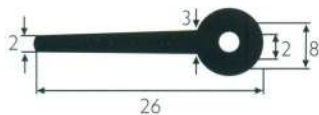

46 238 g/m

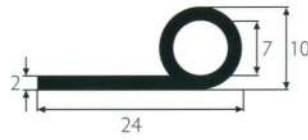

26 123 g/m



29 125 g/m

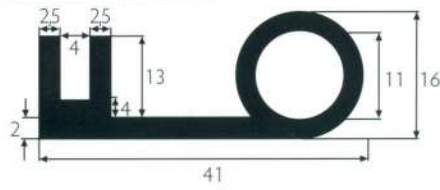

32 538 g/m



35 188 g/m



38 213 g/m



41 131 g/m



44 175 g/m



47 368 g/m



27 56 g/m



30 156 g/m



33 81 g/m



36 181 g/m

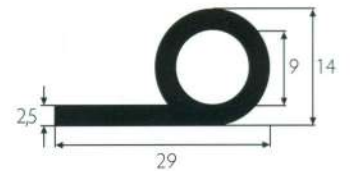

39 250 g/m



42 100 g/m



45 118 g/m



48 143 g/m

Trafilati in Gomma

Qualità EPDM* nera

4

Elastomeri Trafilati

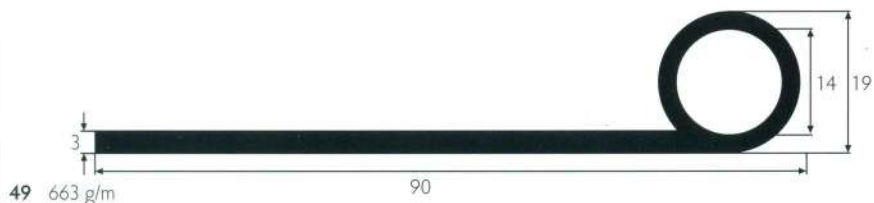

49 663 g/m



101 43 g/m



104 50 g/m



107 75 g/m

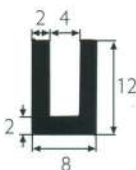

110 81 g/m

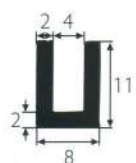

113 88 g/m

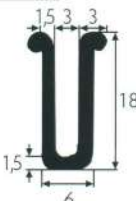

116 113 g/m

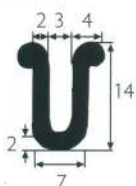

119 113 g/m

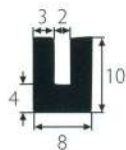

102 100 g/m



105 56 g/m

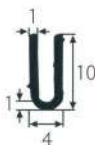

108 48 g/m

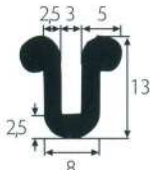

111 131 g/m



114 63 g/m

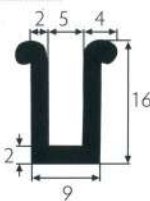

117 138 g/m



120 21 g/m

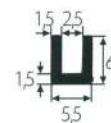

100 38 g/m

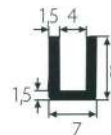

103 40 g/m

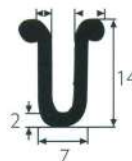

106 113 g/m

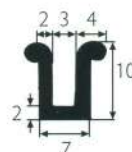

109 70 g/m

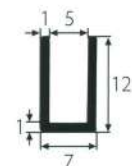

112 75 g/m

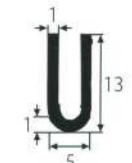

115 65 g/m



118 88 g/m

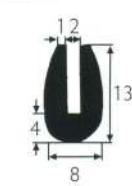

121 125 g/m

Trafilati in Gomma

Qualità EPDM* nera

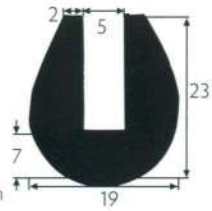

122 313 g/m

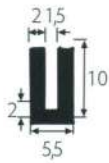

125 75 g/m

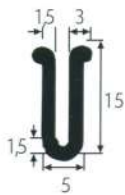

128 88 g/m



131 181 g/m



135 56 g/m

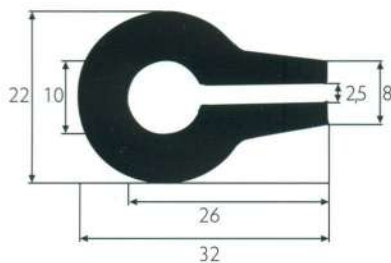

138 513 g/m



123 125 g/m

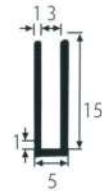

126 56 g/m

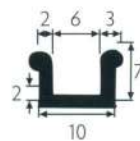

129 88 g/m

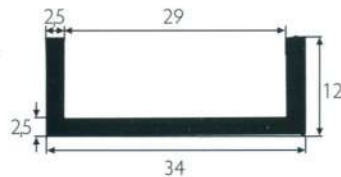

132 175 g/m



136 93 g/m



124 33 g/m

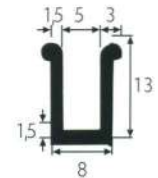

127 75 g/m

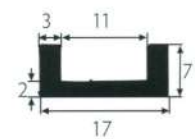

130 113 g/m

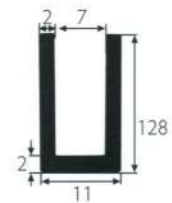

134 143 g/m

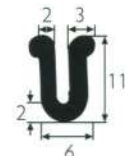

137 81 g/m



139 25 g/m



140 96 g/m



141 213 g/m

Trafilati in Gomma

Qualità EPDM* nera



142 23 g/m



143 135 g/m

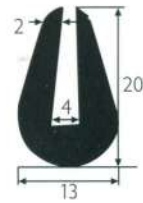

144 150 g/m

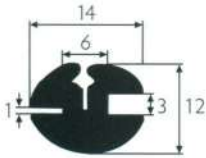

198 160 g/m con spina 260P

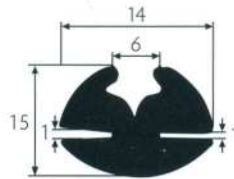

200 393 g/m con spina 260

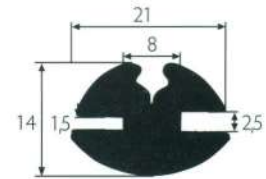

201 325 g/m con spina 260P

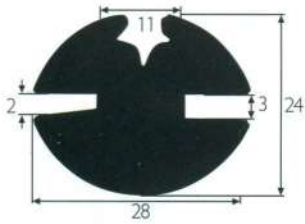

202 625 g/m con spine: 260, 205 e 206

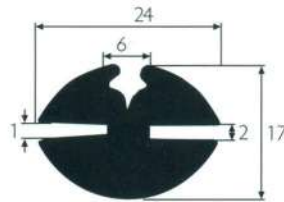

203 437 g/m con spina 260

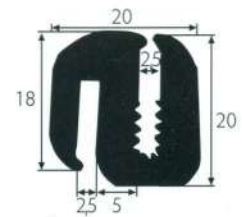

204 388 g/m



205 56 g/m



206 88 g/m

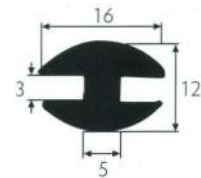

208 200 g/m

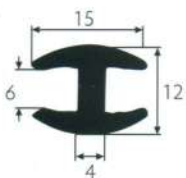

209 145 g/m

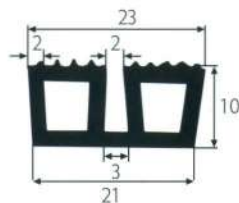

210 293 g/m

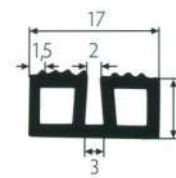

211 138 g/m

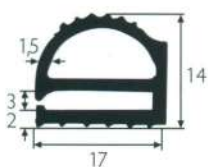

212 131 g/m

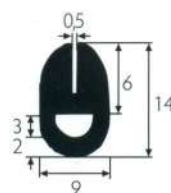

213 125 g/m

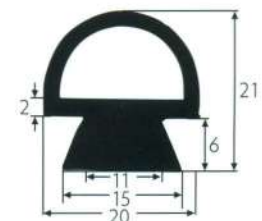

214 463 g/m

Trafilati in Gomma

Qualità EPDM* nera

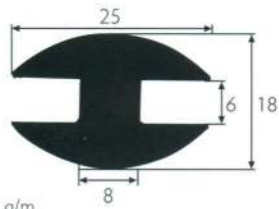

215 331 g/m

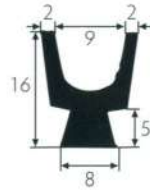

216 131 g/m

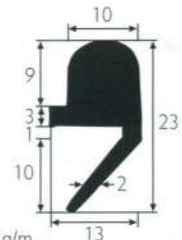

218 273 g/m

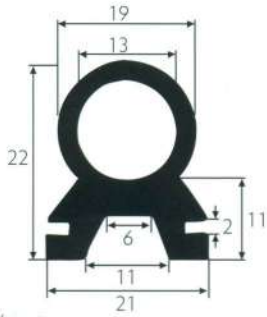

219 375 g/m

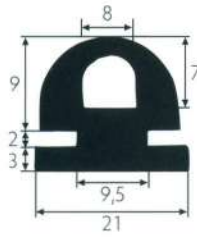

220 356 g/m

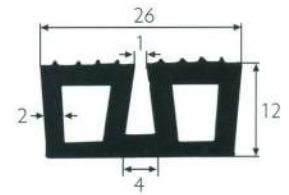

221 300 g/m

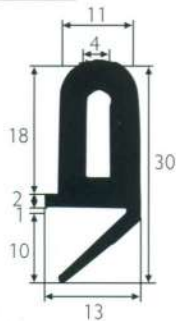

222 316 g/m

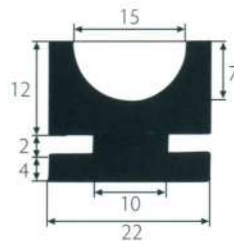

223 500 g/m

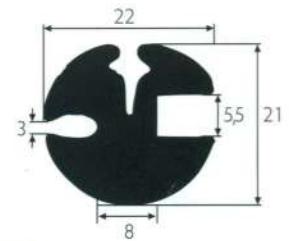

225 563 g/m con spina 260

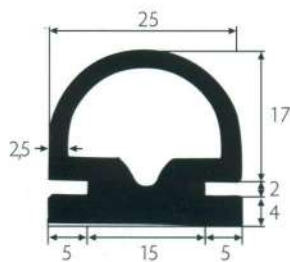

226 388 g/m

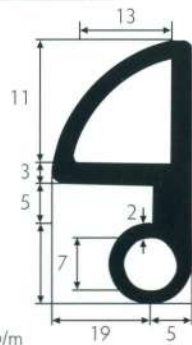

227 438 g/m

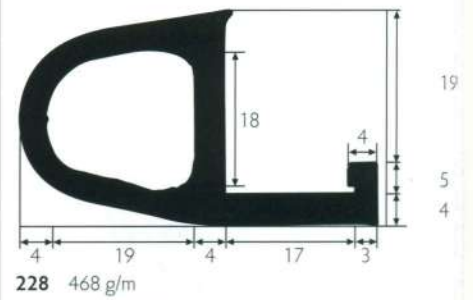

228 468 g/m

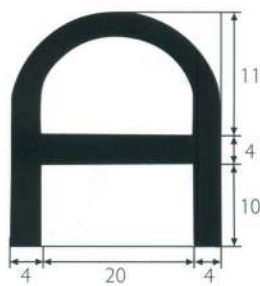

229 410 g/m

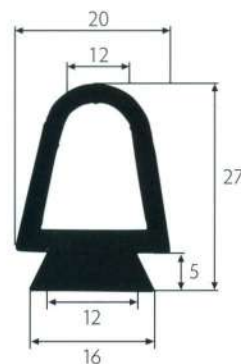

230 425 g/m

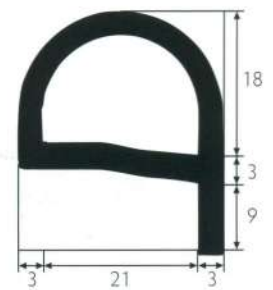

231 375 g/m

Trafilati in Gomma

Qualità EPDM* nera

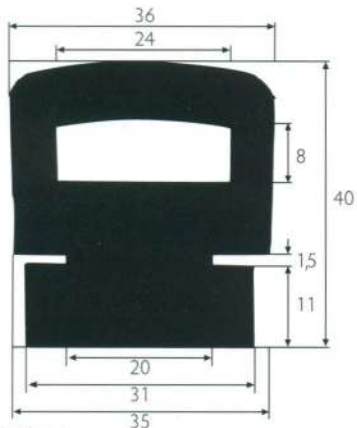

232 1750 g/m

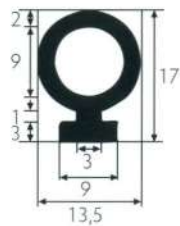

234 180 g/m

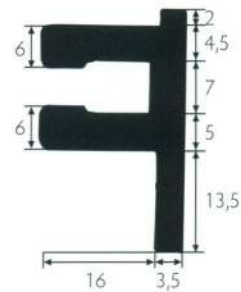

236 500 g/m



237 521 g/m

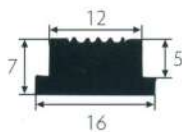

239 125 g/m

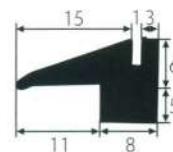

240 133 g/m

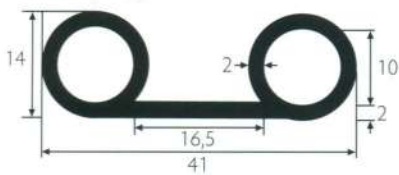

242 313 g/m

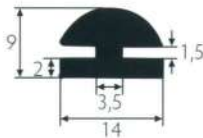

244 133 g/m

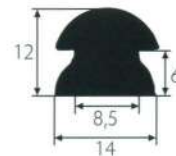

245 188 g/m

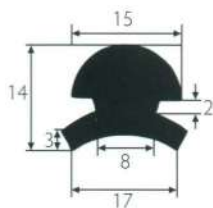

246 263 g/m

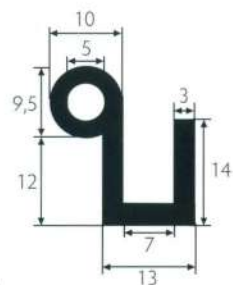

247 243 g/m



250 275 g/m

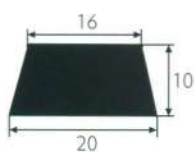

251 313 g/m



252 150 g/m



253 275 g/m

Trafilati in Gomma

Qualità EPDM* nera

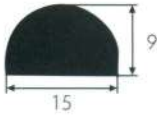

254 193 g/m



257 375 g/m

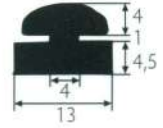

258 163 g/m



260 63 g/m



260/P 40 g/m



261 48 g/m



265 60 g/m

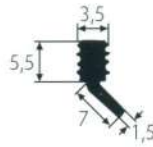

272 50 g/m

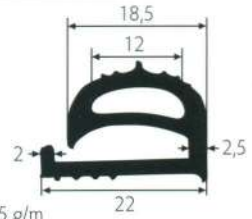

273 175 g/m

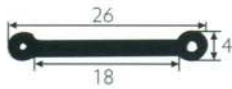

279 525 g/m



280 103 g/m



281 195 g/m



282 135 g/m



285 250 g/m



286 100 g/m

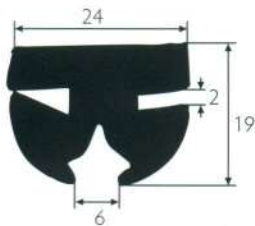

288 563 g/m

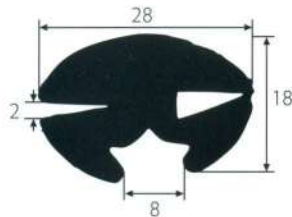

292 563 g/m con spina 260

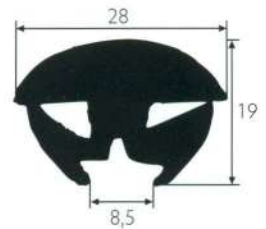

293 563 g/m con spina 205

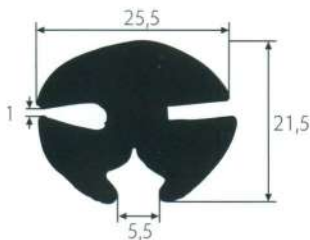

296 563 g/m con spina 260

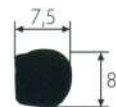

297 81 g/m

Parabordi a delta in Etilpropilene - EPDM

4

Elastomeri Trafilati

V4PD040
SEZIONE 40X22
kg/m 0,7 ca.

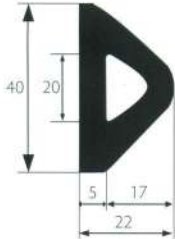

V4PD060
SEZIONE 60X52
kg/m 2 ca.

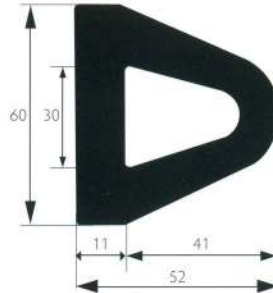

V4PD080
SEZIONE 80X70
kg/m 4 ca.

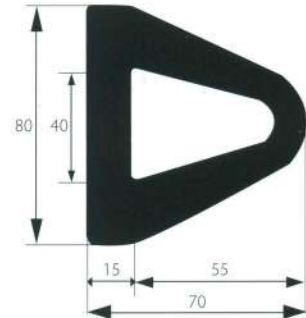

V4PD110
SEZIONE 110X95
kg/m 7 ca.

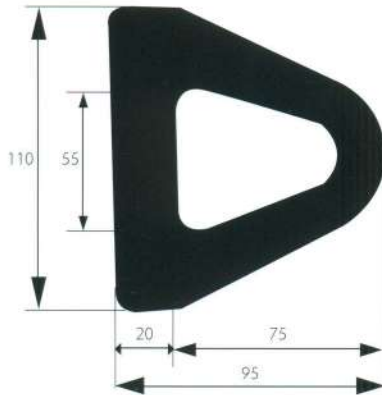

V4PD150
SEZIONE 150X130
kg/m 14 ca.

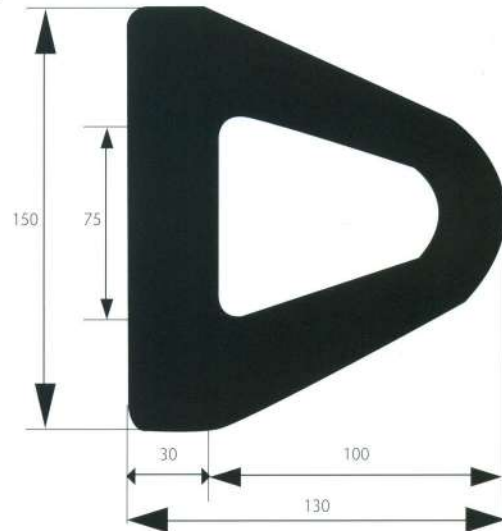

V4PD151
SEZIONE 160X150
kg/m 15,5 ca.

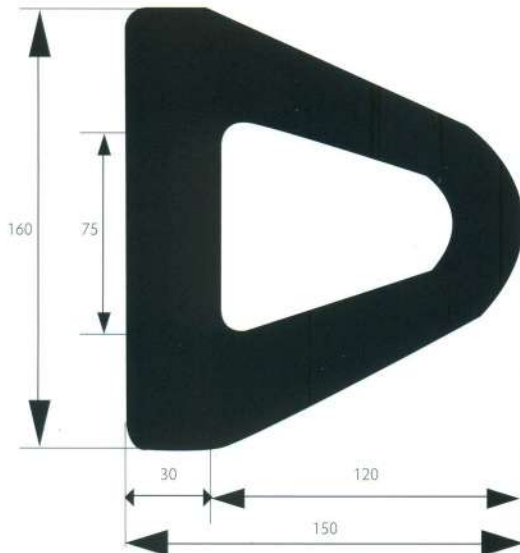

V4PD151K
SEZIONE 150X160 (con smussi*)
kg/m 17 ca.

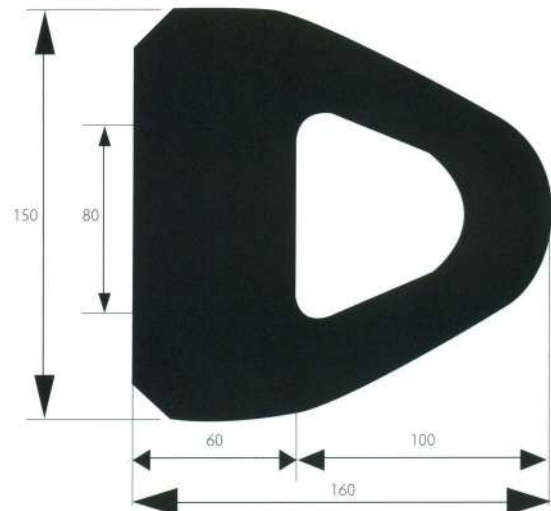

COD.866

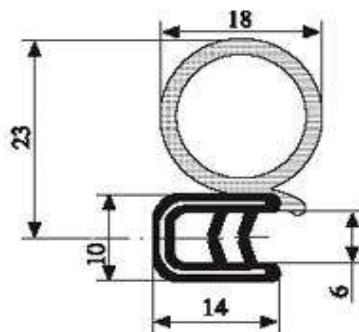

COD.891-3P

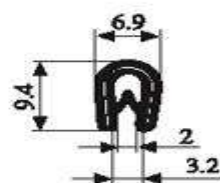

COD.861

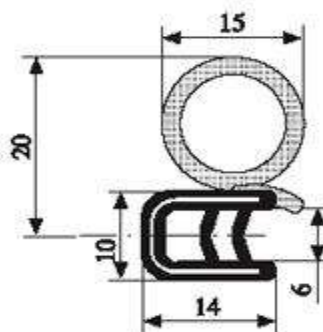

COD.895/6

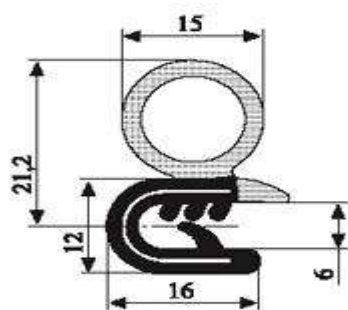

COD.EUR 3

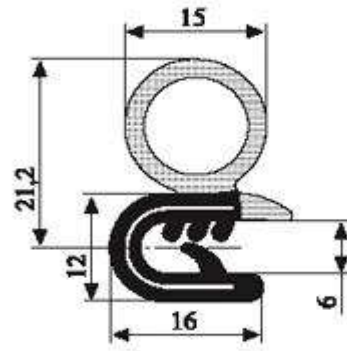

COD.891/1

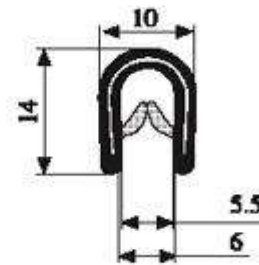

COD.861/2

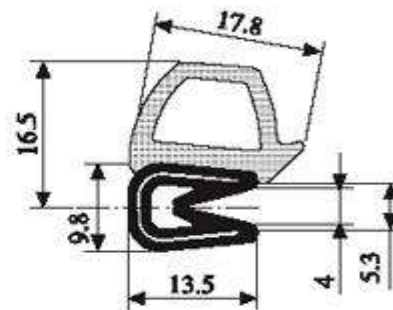

COD.EUR 1

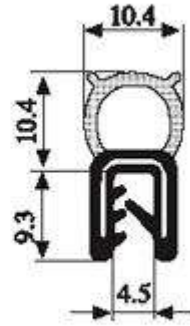

COD.EUR 4

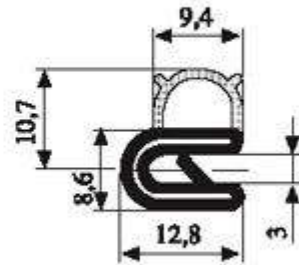

COD.EUR 8

